

SPACE CADETS  
LIGHTING  
ANDROMEDA



// FIELD GUIDE //

# SPACE CAJETS

## Wiring into Wall Outlet

### Step 1

Find the Wall Outlet Cable, and then plug the orange plug into the orange socket on the top of the mount plate. Then route the wire through the small slot so the light sits flush to your ceiling.

### Step 2

Hold the Mount Plate up to your ceiling, then using the included mounting screws attach the Mount Plate by sliding the mounting screws through the slots and drive them into your ceiling. If your ceiling is anything but wood use 4 mounting screws and place two in each slot. Tighten till snug, overtightening can damage the light.

### Step 3

Attach the "Shroud" to the Mount Plate using the 3 included Shroud Screws and wrench. Do this by holding the shroud up to the Mount Plate, and lining up the three screw holes with the brass threaded holes on the mount plate. Then tighten till snug.

### Step 4

Now you can adjust the hanging height of the light. Simply push the braided cord up into the shroud until the light hangs at a nice level. Then using the wrench LIGHTLY tighten the set screw. Do not torque down on this screw, just tighten it until you feel a small amount of resistance and the cord is snug.

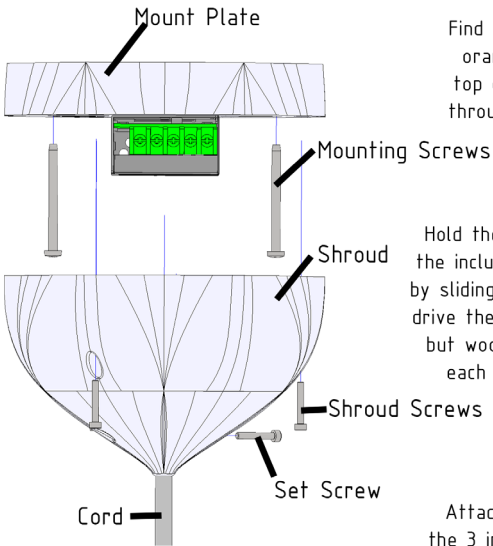

## Wall Outlet Power Cable



## Wrench



# SPACE CADETS

## Wiring into Ceiling Electrical Box

### Step 1

Find the electrical box power cable, then lift the orange and blue levers of the wire connector. Insert the Hot and Neutral wires coming from the electrical box into the connector according to the image below. Then close the levers.

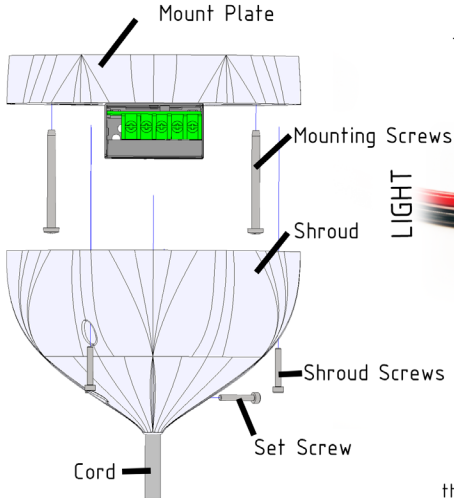

### Step 2

Plug the orange connector into the orange socket on the top of the "Mount Plate".

### Step 3

Hold the Mount Plate over the electrical box and lineup the two slots in the mount plate with the screw holes in the electrical box, then using the included mounting screws attach the Mount Plate to the electrical box by sliding the screws through the slot and into the electrical box hole. Tighten till snug, overtightening can damage the light.

### Step 4

Attach the "Shroud" to the Mount Plate using the 3 included Shroud Screws and wrench. Do this by holding the shroud up to the Mount Plate, and lining up the three screw holes with the brass threaded holes on the mount plate.

Then tighten till snug.

### Step 5

Now you can adjust the hanging height of the light. Simply push the red cord up into the shroud until the light hangs at a nice level. Then using the wrench LIGHTLY tighten the set screw. Do not torque down on this screw, just tighten it until you feel a small amount of resistance and the cord is snug.

## Electrical Box Power Cable



## Wrench



# SPACE CAJETS

## Remote Mounting & Charging



### -Mounting-

Attach magnetic remote mount to wall with the 2 provided remote mount screws. Then the remote will simply magnetically attach to the mount.

### -Charging-

To charge your remote connect a USB-C cable & turn on remote.

It will complete it's charging in around an hour. It pulses orange when it is below 25% charge, aqua when it is between 25 and 75 percent, and green when it is above 75%. When it is full the leds will turn off.

The remote's LED will pulse orange when the battery is below 5 percent. You can also see the remote's battery level in the info tab of the app.

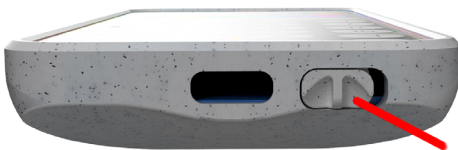

### -Power On/Off-

Switch remote power on/off. Useful if you want to save battery life or carry the remote in a pocket.

# SPACE CAJETS

## The Touch Remote

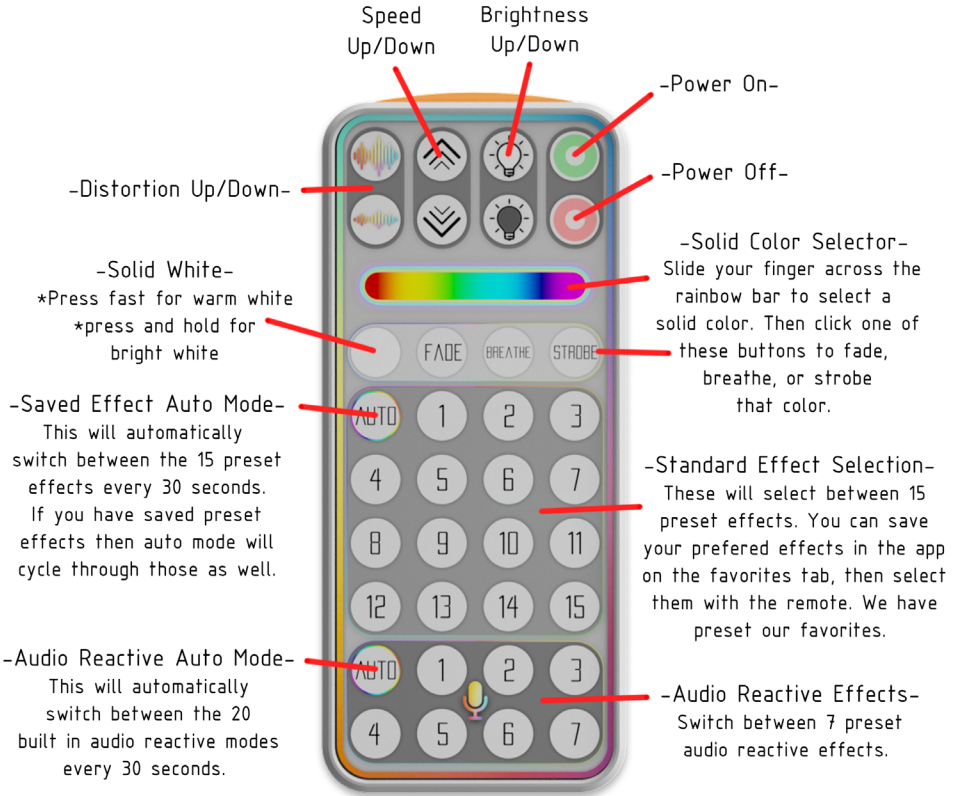

# SPACE CAJETS

## Remote Pairing

Your remote comes out of the box paired to your light, but if you want to pair a different remote to your light follow these instructions :)

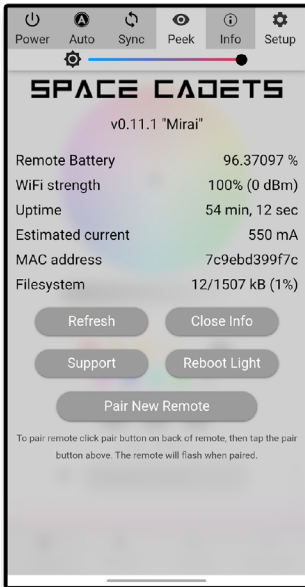

### -Step 1-

Open the app that controls your light, then select your light to open it's controls.

### -Step 2-

Tap the "Info" button at the top of the screen. That will bring up the page in the image on the left.

### -Step 3-

Tap the "Pair New Remote Button", the light will then pulse blue, if it does not then tap the button again.



### -Step 4-

Press and hold the Auto button for 6 seconds to enable Pairing Mode. The remote will pulse blue, then when it pairs to the light it will stop flashing

After that pairing is complete!

Wait for your light to stop pulsing blue then it is ready to use :)

# SPACE CADETS

## Connecting Your Light to the App

STEP 1 - Connect your light to power

STEP 2 - Download the "WLED Native" app in your app store

- Now Follow the steps below -

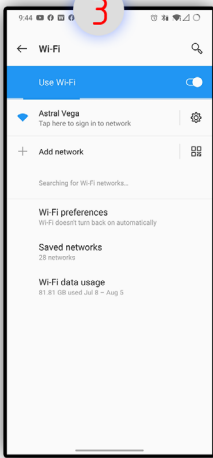

Open your phone WiFi settings and select the name of your light. The Password is "spacecadets".

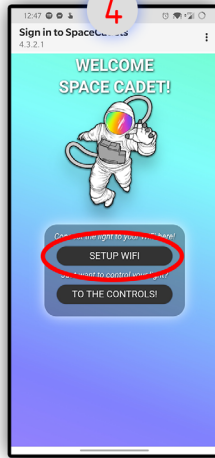

Then tap "Sign in to network". This page will open, tap "SETUP WIFI"

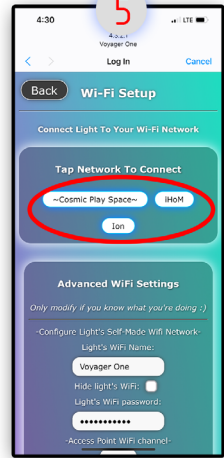

Tap your network's name, then enter it's password and tap "Save and Connect" to connect!

6

Re-connect to your WiFi network.

7

Open WLED Native, if it asks for wifi permission tap yes.

The app will automatically search for lights on your network.

To search for lights again swipe down from the top of the screen.

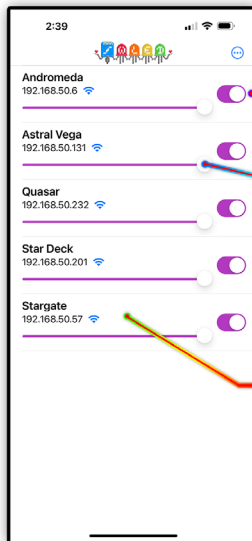

Toggle light on & off

Controls brightness

Tap the center of the light you want to control to load it's full interface.

Swipe from right to left on a light to delete or edit it's name

# SPACE CAJETS

## Using The App - Colors

-Toggle Auto Mode-  
This switches the effect every 30 seconds. If you have presets saved then auto mode will cycle through your presets.

Sync multiple lights together. After you tap sync on both lights select an effect or color.

Shows live preview of effect in the app

This shows statistics about the light.

Light Settings (wifi, etc.)

Brightness

Color Selector

Preset Color Selection

Color Palette Selector-  
You can select the color palette that all the effects use. For example you could select "rainbow" and that would make all the effects rainbow colors. Or you could select "Sunset", which would make all the effects hues of red, yellow, and purple.  
Select "Random Cycle" to automatically flip the color palette every 30 seconds.

Base Color Selector-  
You can use these to set a base color, secondary color, and third color. These will be used throughout the different effects. Black means the leds are off. Usually setting a primary color, then the others to black is a good starting point, but you can play with these and experiment!

Page Tabs

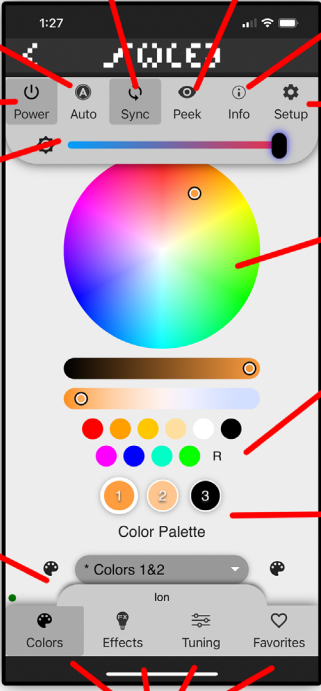

The screenshot shows the app's main interface. At the top, there's a status bar with the time 1:27 and signal strength. Below that, the app title 'SPACE CAJETS' is displayed in a stylized font. A navigation bar contains icons for Power, Auto, Sync, Peek, Info, and Setup. Below the navigation bar is a brightness slider. The main area features a large color wheel (Color Selector) and a horizontal bar for Preset Color Selection. Below these are three colored circles (Base Color Selector) and a Color Palette selector. At the bottom, there are four page tabs: Colors, Effects, Tuning, and Favorites. Red arrows point from text annotations to these various UI elements.

This is the "Colors" Page highlighted in grey,

The "Effects" page is where you can change the light's effect.

The "Tuning" page is where you can change speed, distortion, and sound reactance of the effects.

The "Favorites" page is where you can save and select your favorite effects.



# SPACE CAJETS

## Using The App - Effects

The "Solid" Effect sets the light to whatever color you select on the "Colors" page with the color wheel.

Effects with only a Music Note will react to the volume of your music.

Effects with a note and an f will react to the tone of your music. So they will listen to the song's trebel and bass, then generate patterns that respond in sync.

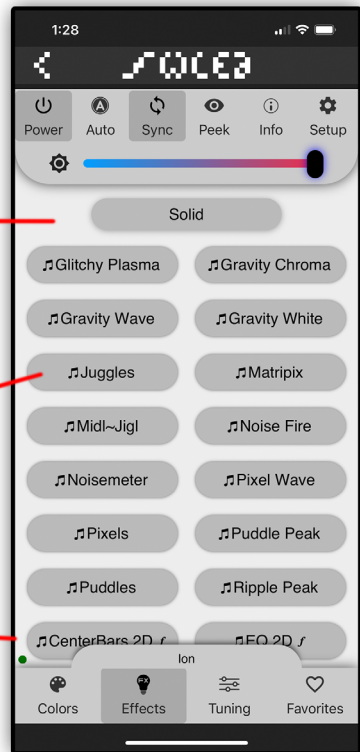

To select an effect simply scroll through the effects and tap any of the effects to select it.

All of the effects without a music note do not respond to sound. Simply select the effect and it will play on the light!

# SPACE CAJETS

## Using The App - Tuning

The Distortion slider changes a different part of each effect. For example if the effect has bouncing dots then this would change the number of dots. Just experiment and see what changes!

This changes how much the light reacts to music. If your music is quiet then turn this up, if it is loud then turn this down.

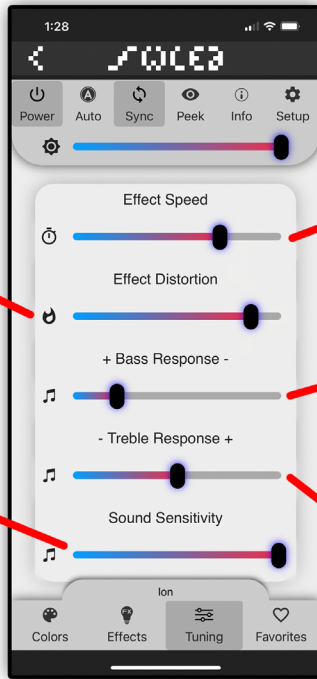

This changes the speed of the effect.

Bass Response changes how the light reacts to bass in your music. Slide it to the left for more response to bass, and the right for less.

Trebel Response changes the lights response to trebel in your music. Slide to the right for more response, to the left for less.

Play with these sliders and really tune how the effect reacts!  
If you find a combination of tuning you love then save it as a preset on the favorites page :)

\*The Bass, Trebel, and Sound Sensitivity sliders only are used when a sound reactive effect is playing.

# SPACE CAJETS

## Using The App - Favorites

Here you can save your favorite effects and load them quickly!

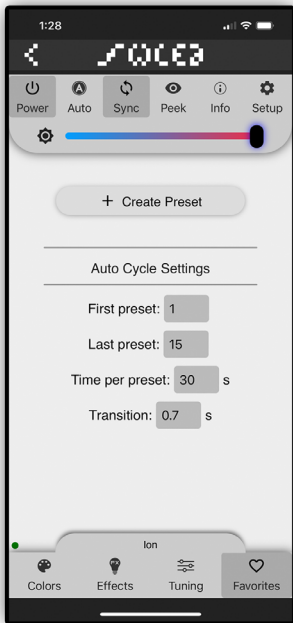

To save an effect tap  
"Create Preset".

Then you can name it here,  
and add a quick load label  
if you would like.

If "save current state" is  
checked then the effect  
that is currently playing is  
saved, and the exact tuning of  
the sliders will all be saved.  
If "include brightness" is  
checked then the preset  
will save the current  
brightness.

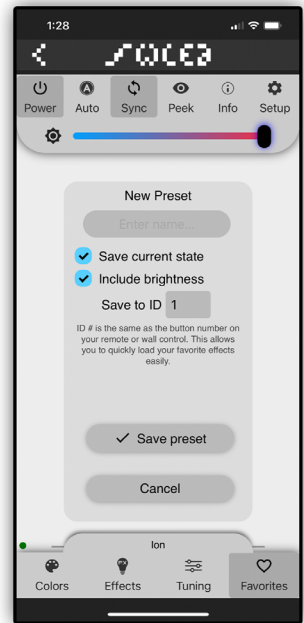

Auto cycle mode cycles through the buttons 1-15 of your remote by default.

If you create a preset and save it to ID #1 for example then button 1 on your remote will play that preset when pressed, and Auto mode will play that preset when auto mode is enabled instead of the default #1 effect.

### -Auto Cycle Settings-

Here you can change the Auto Cycle settings.

First Preset- What preset do you want to start with?

Last Preset- What preset do you want to end with?

Time Per Preset- How many seconds should each effect play.

Transition- How many seconds do you want the light to fade between presets?

(Auto mode will cycle through all the presets between the first and last)

**BY SPACE CAJETS**



**FOR SPACE CAJETS**